

# UNE HISTOIRE DE L'ARCHITECTURE DES ORDINATEURS

## Dans l'antiquité



Machine d'Anticythère



Odomètre de Héron d'Alexandrie

# Pascaline – Pascal, 1642

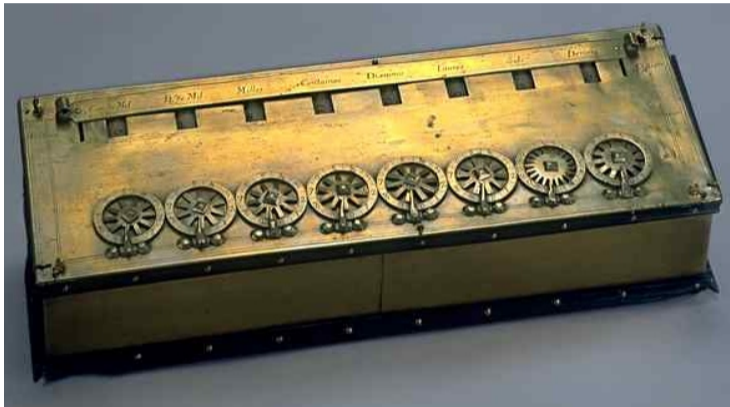

# Machine analytique – Babbage, 1834

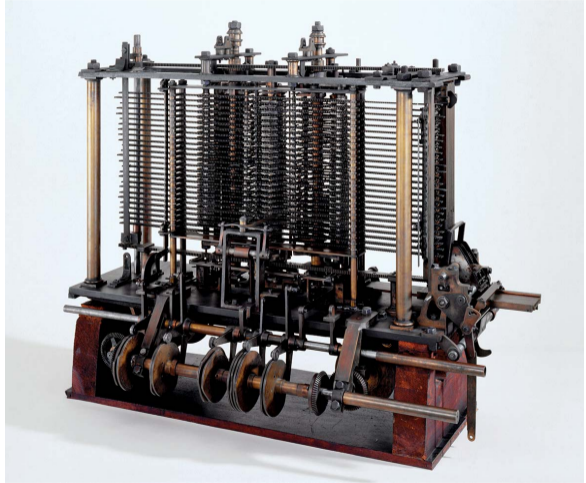
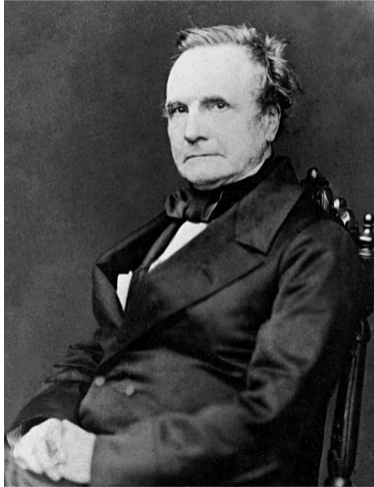

# Premier programme informatique – Lovelace, 1843



# A Symbolic Analysis of Relay and Switching Circuits – Shannon, 1937

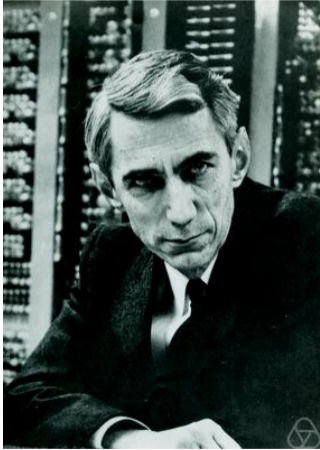

Claude Shannon

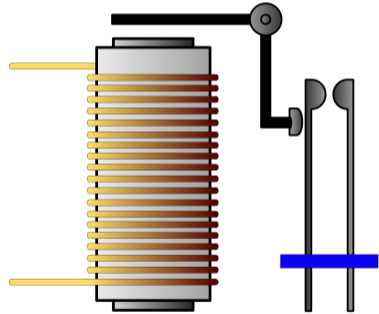

# ENIAC – Mauchly et Eckert, 1945

- Premier ordinateur électronique
- Comporte 17 468 tubes à vide

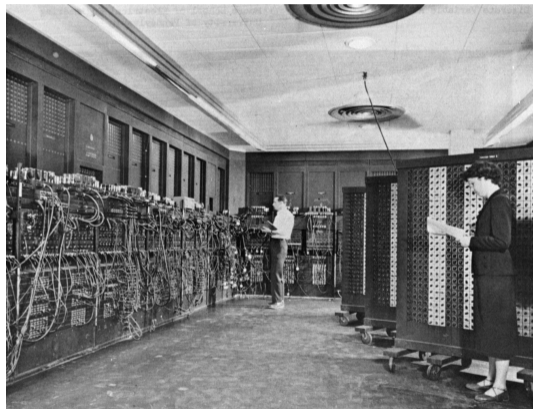

# First Draft of a Report on the EDVAC – von Neumann, 1945



John von Neumann

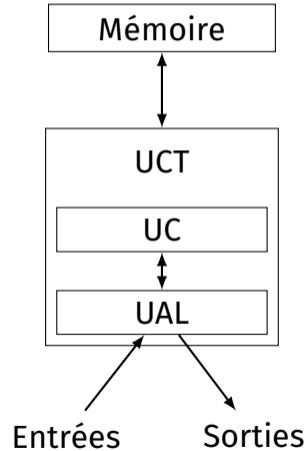



# Transistor – Bardeen, Shockley, Brattain, 1948

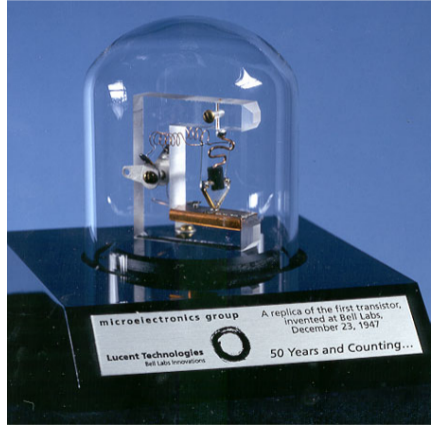

# Circuit intégré – Kilby, Noyce, 1958



Jack Kilby



Robert Noyce

# MOS Transistor – Atalla, Kahng, 1959



Mohamed Atalla



Dawon Kahng

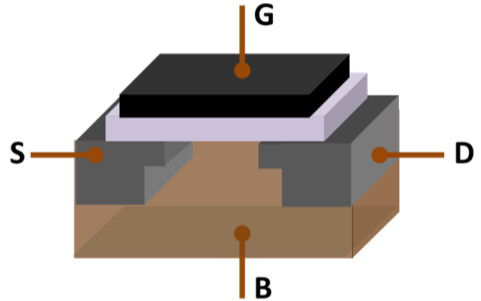

# 7400 – Texas Instrument, 1966

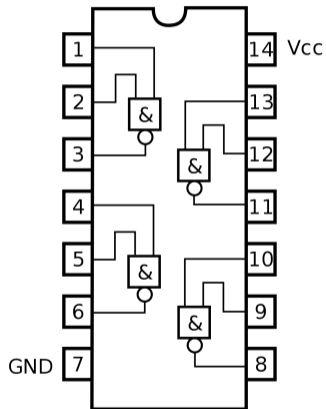
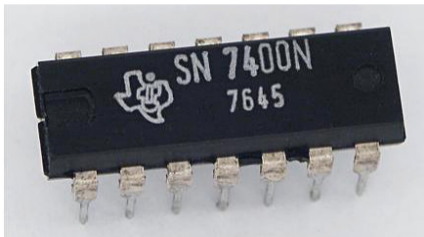

# 7400 – Texas Instrument, 1966

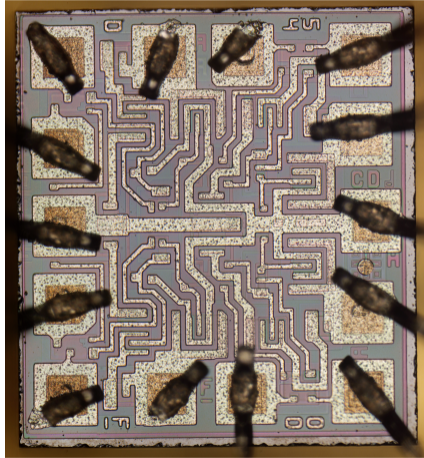

# 4004 – Intel, 1971

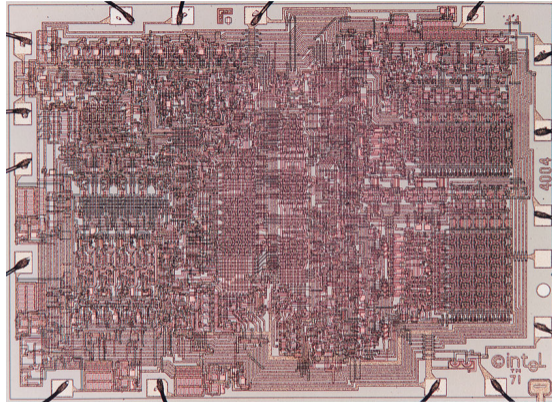

	Sortie	Fréq.	Transistors	Surface	Gravure (nm)
4004	1971	740 kHz	2300	12 mm <sup>2</sup>	10 000

## POWER4 – IBM, 2001

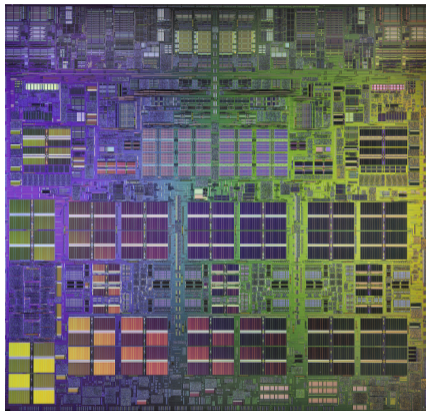

	Sortie	Fréq.	Transistors	Surface	Gravure (nm)
4004	1971	740 kHz	2300	12 mm <sup>2</sup>	10 000
Power4	2001	1.1 GHz	174 000 000	412 mm <sup>2</sup>	180

# Architecture moderne, carte mère

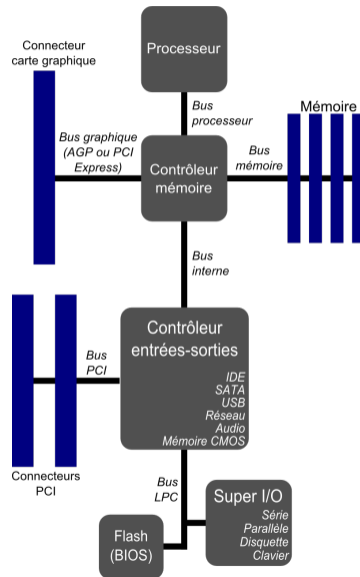
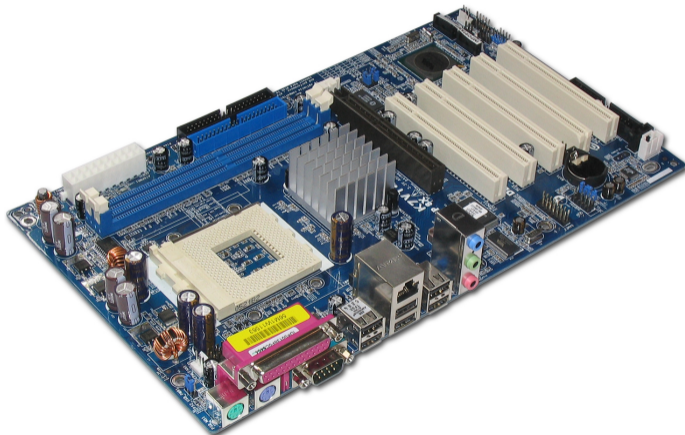



# Raspberry Pi 3 B+ – Raspberry Pi Foundation, 2018

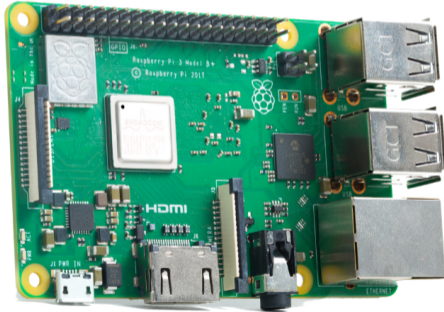

## Broadcom BCM2837Bo

- 4 cœurs Cortex-A53  
64-bit à 1.4GHz
- 1GB LPDDR2 SDRAM
- Wifi, Bluetooth
- Ethernet
- USB
- HDMI

## Snapdragon 855 – Qualcomm, 2018

	Sortie	Fréq.	Transistors	Surface	Gravure
Intel 4004	1971	740 kHz	2300	12 mm <sup>2</sup>	10 000
IBM Power4	2001	1.1 GHz	174 000 000	412 mm <sup>2</sup>	180
Snapdragon 855	2018	1.8 GHz	6 700 000 000	73 mm <sup>2</sup>	7